



FITTING INSTRUCTIONS

PART NUMBER AND DESCRIPTION:
3648210 – SUMMIT REAR STEP TOW BAR (RSTB)

SUITED TO VEHICLE/S:
ISUZU DMAX 2012 ON

WARNING

NOTE THE FOLLOWING:

- ◆ This product must be installed exactly as per these instructions using only the hardware supplied.
- ◆ In the event of damage to any tow bar component, contact your nearest authorised ARB stockist.
- ◆ Do not use this product for any vehicle make or model, other than those specified by ARB.
- ◆ Do not remove labels from this tow bar.
- ◆ This product or its fixing must not be modified in any way.
- ◆ The installation of this product may require the use of specialized tools and/or techniques
- ◆ It is recommended that this product is only installed by trained personnel.
- ◆ These instructions are correct as at the publication date. ARB Corporation Ltd. cannot be held responsible for the impact of any changes subsequently made by the vehicle manufacturer.
- ◆ During installation, it is the duty of the installer to check correct operation/clearances of all components.
- ◆ Work safely at all times.
- ◆ Unless otherwise instructed, tighten fasteners to specified torque.
- ◆ The eyelets on the rear bar have been designed and tested for connection of trailer safety chains. They are not to be used for recovery or direct towing.
- ◆ For recovery, fit a suitable and rated tow hitch to the central tow hitch receiver.
- ◆ Position high lift jack at lift locations beneath the middle of the wings and corner of the RSTB. Do not lift directly from the end of the wing.
- ◆ When using the tow hitch receiver, the centre panel should be in the raised position.

ARB 4x4 ACCESSORIES

Corporate Head Office

42-44 Garden St
Kilsyth, Victoria
AUSTRALIA 3137

Tel: +61 (3) 9761 6622
Fax: +61 (3) 9761 6807

Australian enquiries
North & South American enquiries
Other international enquiries

sales@arb.com.au
sales@arbusa.com
exports@arb.com.au

www.arb.com.au

GENERAL CARE AND MAINTENANCE

By choosing an ARB Bar, you have bought a product that is one of the most sought after 4WD products in the world. Your bar is a properly engineered, reliable, quality accessory that represents excellent value. To keep your bar in original condition it is important to care and maintain it following these recommendations:



- Prior to exposure to the weather your bar should be treated to a Canuba based polish on all exposed surfaces. It is recommended that this is performed on a six monthly basis or following exposure to salt, mud, sand or other contaminants.
- As part of any Pre Trip Preparation, or on an annual basis, it is recommended that a thorough visual inspection of the bar is carried out, making sure that all bolts and other components are torqued to the correct specification. Also check that all wiring sheaths, connectors, and fittings are free of damage. Replace any components as necessary. This service can be performed by your local authorized ARB Stockist.

FITTING REQUIREMENTS

REQUIRED TOOLS FOR FITMENT OF PRODUCT:

BASIC TOOL KIT	SIDE CUTTERS
INSULATION TAPE	70MM HOLE SAW BIT
6.5MM DRILL BIT	WIRE STRIPPER
DEUTSCH CRIMPING TOOL	POWER DRILL
NEEDLE NOSE PLIERS	SOCKET SET
ALLEN KEY SET	TAPE MEASURE
FINE ROUND FILE	RUST PREVENTATIVE PAINT
MASKING TAPE	SOLDERING IRON + SOLDER
HEAT SHRINK + HEAT GUN	T40 TORX BIT
MULTIMETER	

HAVE AVAILABLE THESE SAFETY ITEMS WHEN FITTING PRODUCT:

Protective eyewear		Hearing protection	
--------------------	---	--------------------	---

NOTE: 'WARNING' notes in the fitting procedure relate to OHS situations, where to avoid a potentially hazardous situation it is suggested that protective safety gear be worn or a safe work procedure be employed. If these notes and warnings are not heeded, injury may result.

FASTENER TORQUE SETTINGS:

SIZE	Torque Nm	Torque lbft
M6	9 Nm	7 lbft
M8	22 Nm	16 lbft
M10	44 Nm	32 lbft
M12x1.75	77 Nm	57 lbft
M12x1.25	95 Nm	71 lbft

RSTB PARTS LISTING

APPLICATION	PART NO.	QTY	DESCRIPTION
PREPARE REAR STEP TOW BAR (RSTB)	6523002	1	LIFT UP PANEL
	5670026	2	SPRING EXT 11.25 OD x 43
	6602011	2	CANOE CLIP BLACK
	6151256	2	SCREW BTN HD M6 x 16 SS
	6151549	2	NUT NYLOC M6 x 1.0 GR8.8 BTZP480
	4584295	4	WASHER FLAT M6 x 12 x 1.3 BLK ZN
RSTB TO VEHICLE	3759108	2	CHASSIS WELD NUT PLATE
	6151096	10	BOLT HXHD M12 x 1.25 x 40 CL8.8 ZP
	4581050	10	WASHER SPRING 1/2 x 3/16 x 3/16 ZP
	4581007	10	WASHER FLAT 1/2 x 1 1/2 x 4 SILVER TZP
BEAVER PANEL TO VEHICLE	6523055	1	BEAVER PANEL DMAX
	3759642	1	LICENSE PLATE MOUNT
	3759695R	1	LICENSE PLATE BRACKET RH
	3759695L	1	LICENSE PLATE BRACKET LH
	3194833	1	PLATE 10MM SPANNER
	6821189	4	PLASTIC SNAP-IN LARGE GROMMET
	6151384	4	SCREW ST PHDCOL PH 5.2 x 16 TBZP480
	6151295	6	SCREW BTN HD M8 x 20 SS
	4581081	6	WASHER FLAT M8 SS
	4581063	4	WASHER FLAT M8 x 25 x 3 ZN
	4581082	2	WASHER FLAT M6 x 19 x 1.6 BLK ZN
	6151549	6	NUT NYLOC M6 x 1.0 GR8.8 BTZP480
	6151213	8	BOLT M6 x 1.0 x 20 Gd8.8 BZ
	4581287	2	WASHER SPRING M6 x 2.5 x 1.6 BLK ZN
	4584295	14	WASHER FLAT M6 x 12 x 1.3 BLK ZN
5848302	2	PACKER RB NYLON	
STEP PLATE TO RSTB	3194759	1	STEP PLATE EXTRUSION DMAX
	3163125	1	LIGHT BEZEL MOULDING
	3750395	1	LED MOUNT BRACKET
	6151256	8	SCREW BTN HD M6 x 16 SS
	6151715	16	NUT M6 CAGED 3.6-4.5mm 836-D
	6821270	1	NARVA 90810 LED LAMP KIT
	6821116	2	PLASTIC SNAP-IN SMALL GROMMET
PREPARE RSTB/VEHICLE FOR PANELS	3789532	1	TEMPLATE RSTB DMAX WING H/CUT
	3759681R	1	BRKT CLRADO/DMX WING R MNT RH
	3759681L	1	BRKT CLRADO/DMX WING R MNT LH
	3759680R	1	BRKT CLRADO/DMX WING F MNT RH
	3759680L	1	BRKT CLRADO/DMX WING F MNT LH
	3194723	2	WING DOUBLE NUT PLATE
	3194724	2	WING TRIPLE NUT PLATE
	4581048	2	WASHER SPRING M10 TZP480
	6151022	6	BOLT M8 x 1.25 x 25 Gd 8.8 ZP
	4581063	6	WASHER FLAT M8 x 25 x 3 GOLD ZN
	4581046	6	WASHER SPRING M8 x 3/32 x 3/32
	6151204	2	BOLT M10 x 1.5 x 35 Gd 8.8 ZP
	4581040	2	WASHER FLAT M10 x 25 x 3 ZP
	6151302	2	NUT CAGED M10 1.8-3.2
3194869	2	CAGE PLATE 225mm	

RSTB PARTS LISTING

PANELS TO RSTB/VEHICLE	6151022	8	BOLT M8 x 1.25 x 25 Gd 8.8 ZP
	4581063	16	WASHER FLAT M8 x 25 x 3 GOLD ZN
	4581046	4	WASHER SPRING M8 x 3/32 x 3/32
	6151032	8	NUT NYLOC M8 x 1.25
	6151256	8	SCREW BTN HD M6 x 16 SS
	4581304	8	WASHER FLAT M6 SS
	6151213	2	BOLT M6 x 1.0 x 20 Gd8.8 BZ
	4581082	2	WASHER FLAT M6 x 19 x 1.6 BLK ZN
	4584295	2	WASHER FLAT M6 x 12 x 1.3 BLK ZN
	6151549	2	NUT NYLOC M6 x 1.0 GR8.8 BTZP480
	6151710	4	M8 x 25 TORX GR8.8 BZ480
	3194718	2	WING WASHER PLATE
	3131521R	1	DMAX WING RH
	3131521L	1	DMAX WING LH
	6523048	1	DIFFUSER PANEL RH
6523049	1	DIFFUSER PANEL LH	
TOW TONGUE	4761170	1	TOW TONGUE 45 DEG
	55010	1	TOW BAR PULL PIN
	55020	1	SPRING CLIP
	180302	10	CABLE TIE 200mm

TRAILER WIRING

The following trailer wiring solutions can be purchased from ARB. Purchase the main wiring harness with ECU (Part no. 3600010) in conjunction with the appropriate socket and tail listed below. Alternatively, this product is compatible with the factory trailer wiring solution.

To install this loom, a crimping tool suitable for crimping contact type size 16 Deutsch pins is required. Suitable crimping tools can be purchased from auto electrical wholesalers as shown.



APPLICATION	PART NO.	QTY	DESCRIPTION
TRAILER WIRING	3600010	1	RSTB WIRING INCLUDING ECU
	3600020	1	RSTB SOCKET & TAIL 7 PIN FLAT
	3600030	1	RSTB SOCKET & TAIL 12 PIN FLAT
	3600040	1	RSTB SOCKET & TAIL 7 PIN ROUND LRG
	3600050	1	RSTB SOCKET & TAIL 7 PIN ROUND SML

OPTIONAL ACCESSORIES

The following ARB accessories can be fitted to this product:

APPLICATION	PART NO.	QTY	DESCRIPTION
OPTIONAL ACCESSORIES	171403	1	ARB AIR LINE FITTING
	10600030	1	ARB TRAILER CAMERA KIT
	58X22/A	1	RECOVERY HITCH AND SHACKLE
	6594050	1	50 AMP ANDERSON PLUG
			
AIR LINE FITTING	TRAILER CAMERA KIT	RECOVERY HITCH	ANDERSON PLUG

GENUINE ACCESSORIES REMOVAL



1. Remove the spare wheel from beneath the tub using the wheel nut wrench and jack handle pieces supplied with the vehicle.
2. Disconnect the licence plate lamp and/or tow wiring looms from the vehicle loom at the location shown.
3. Disconnect the connector as shown.

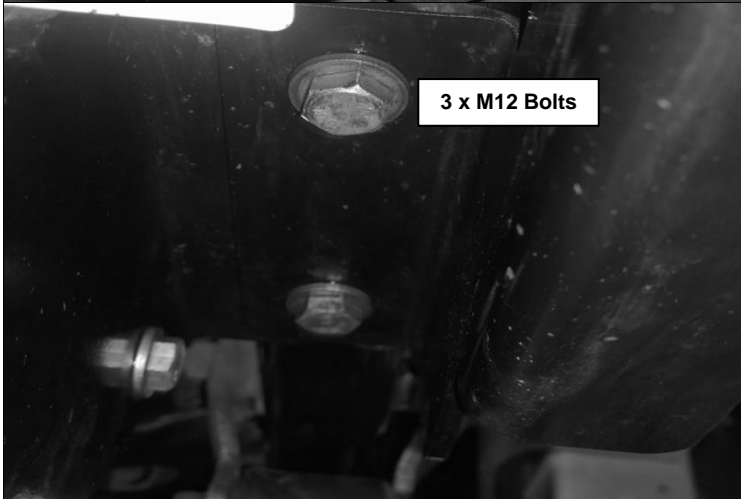

4. Remove the bumper bar from the vehicle by removing M12 bolts from each chassis rail as shown.
5. Remove licence plate loom from bumper and set aside for later use.



For vehicles fitted with a tow bar:

6. Remove the factory tow bar from the vehicle by removing the M12 bolts from each chassis rail.
7. Disconnect the trailer plug from the tow bar by removing the loom fasteners. Place the plug to the side where it will not be damaged during fitment of the Rear Step Tow Bar (RSTB).

VEHICLE/RSTB WIRING

A trailer wiring solution that incorporates a smart ECU is available for this vehicle. To fit this solution, the rear vehicle wiring harness must be cut and high quality, waterproof Deutsch connectors installed to provide signal pickup points for the ECU.

To install this loom, a suitable crimp tool is required. Refer to Page 4 for more details about the crimp tool.

Follow the steps below to install the trailer wiring solution:

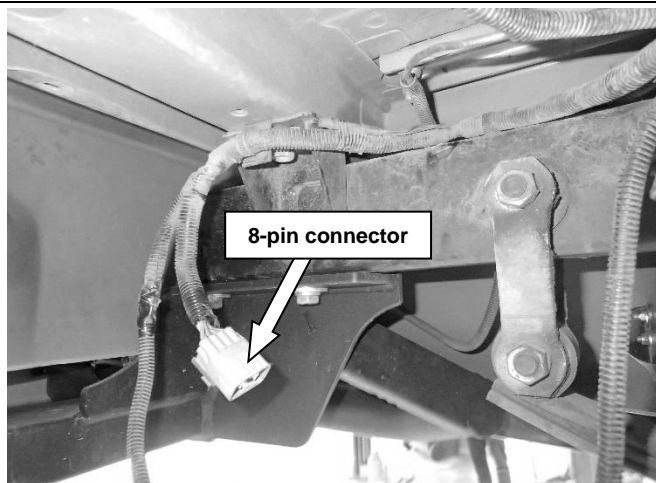

8. Locate the 8-pin connector on the inside of the left chassis rail near the rear bumper as shown. Remove 200mm of tape and corrugated tubing if present from behind the 8-pin connector.



9. Identify each of the 5 wires listed in the table below using the colours stated, and use a multimeter to ensure that each wire corresponds to its respective function as per below table.
10. Cut each of these wires as shown to remove 50mm of wire from the centre of each wire, this will leave 75mm on either end (to aid in crimping).

Wire colour	Function
Black/Red	Reverse
Yellow	LHS Indicator
Red	Brakes
Brown/Red	Clearance/Parker
Green	RHS Indicator

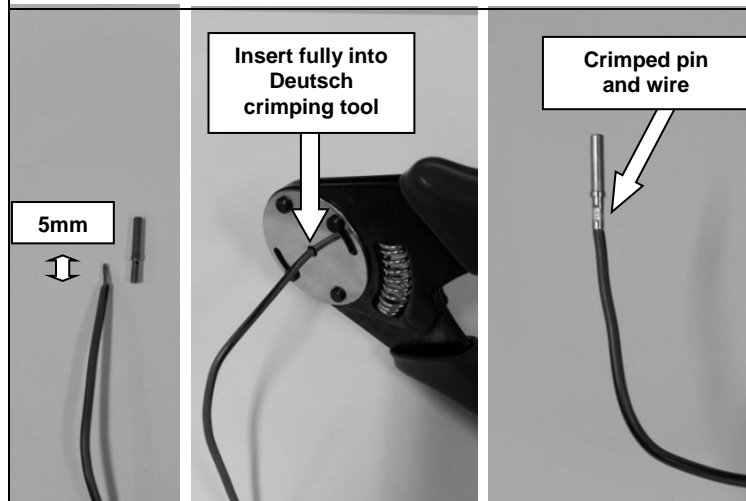

11. Remove 5mm of the plastic insulation coating from the end of each newly cut wire.
- Note: For thin wires, consider exposing 10mm of copper and fold back on itself to increase thickness for a better crimp connection.**
12. Insert each wire into the shorter end of a metal Deutsch pin (*supplied with the 3600010 RSTB Wiring Harness*)
13. Insert the longer end of the metal Deutsch pin into a crimping tool and crimp the wire and pin together as shown.

VEHICLE/RSTB WIRING

White blank pin
in position 6

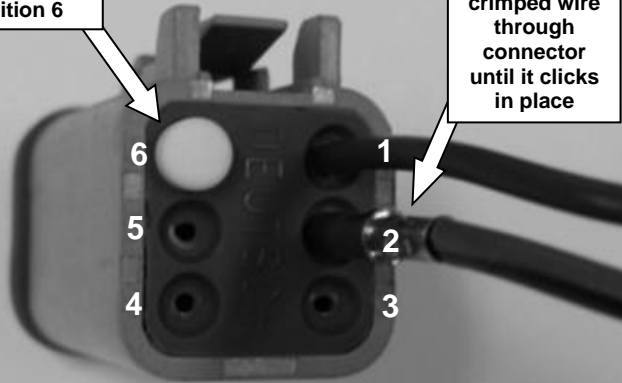

Push
crimped wire
through
connector
until it clicks
in place

14. Insert one set of wires into a male 6-pin connector (*supplied with the 3600010 RSTB Wiring Harness*) from the back in the following order:

Pin position	Wire colour
1	Yellow (LH Ind)
2	Black/Red (Rev)
3	Green (RH Ind)
4	Red (Brake)
5	Brown/Red (Clr/Park)

Note: Pin positions are shown on the back of the connector.

Plastic cover on
the front side of
connector

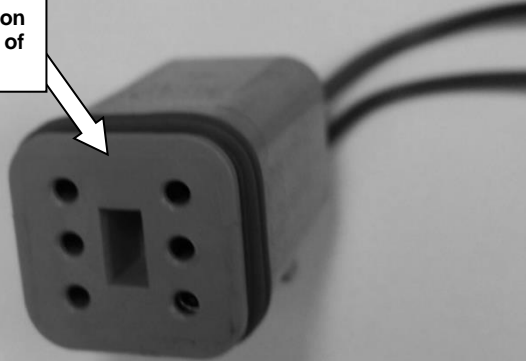

15. Insert the white blank pin into position 6 as shown in the previous step.
16. Insert the plastic cover to the front of the connector as shown.
17. Repeat steps 14-16 for the other connector

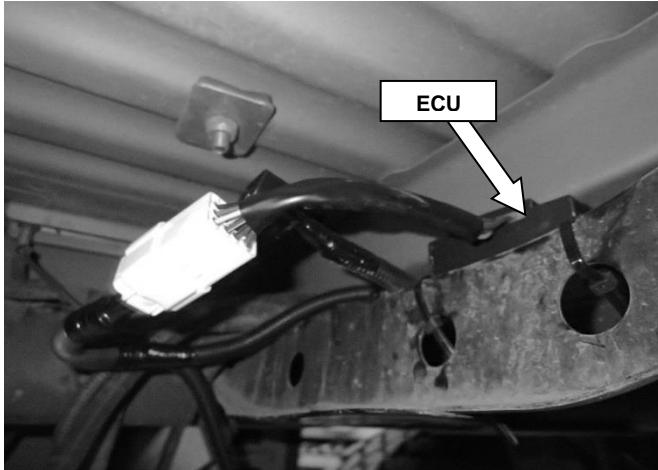

ECU

18. Position the ECU on top of cross member beneath tub as shown. Secure using the ECU mounting holes and vehicle harness with 2 cable ties.
19. Connect 12-pin connector on RSTB Wiring Harness to ECU

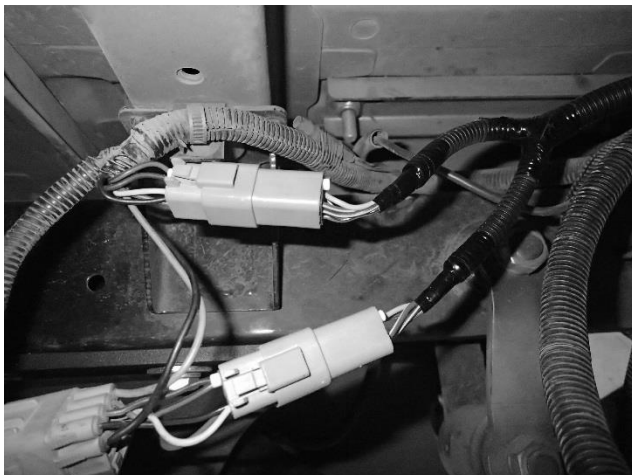

20. Connect the RSTB wiring harness to the 2 male 6-pin connectors.

Note: The RSTB wiring harness is not polarity sensitive in this region so the male 6-pin connectors can be connected to either female connector.

VEHICLE/RSTB WIRING

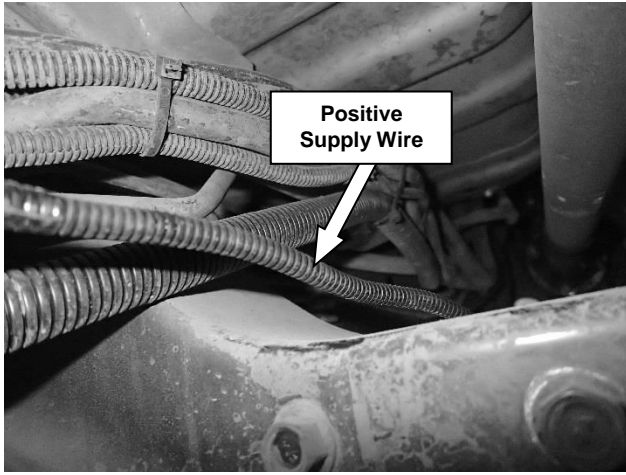

21. Route the positive supply wire to the front of the vehicle following the existing vehicle harness along the left chassis rail.

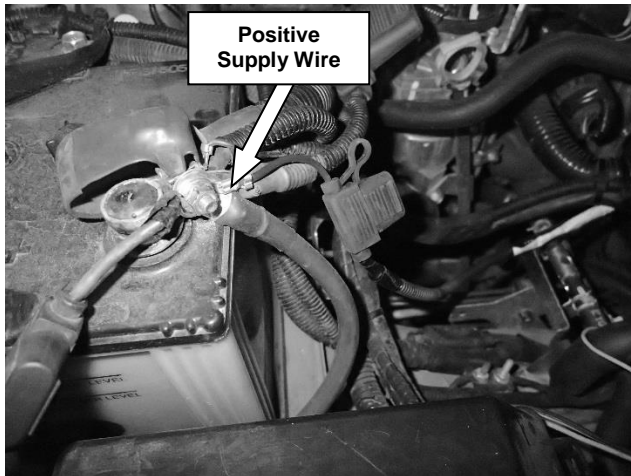

22. Connect the positive supply wire to the positive terminal of the battery as shown.



23. Connect the ground wire of the RSTB harness to the bolt on the inside of the rear chassis rail as shown.



24. Tidy and fasten all wiring using the cable ties provided.

Warning: Make sure all wires are securely fastened away from any hot, sharp or moving surfaces. Do not fasten wiring harness to fuel or brake lines.

25. Ensure vehicle tail lights function correctly

PREPARE REAR STEP TOW BAR (RSTB)

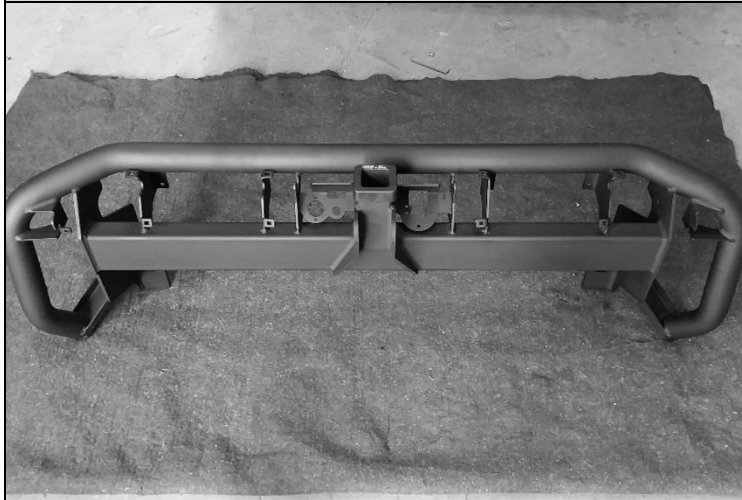

26. Place the RSTB on a flat surface that will not damage its coating as shown.

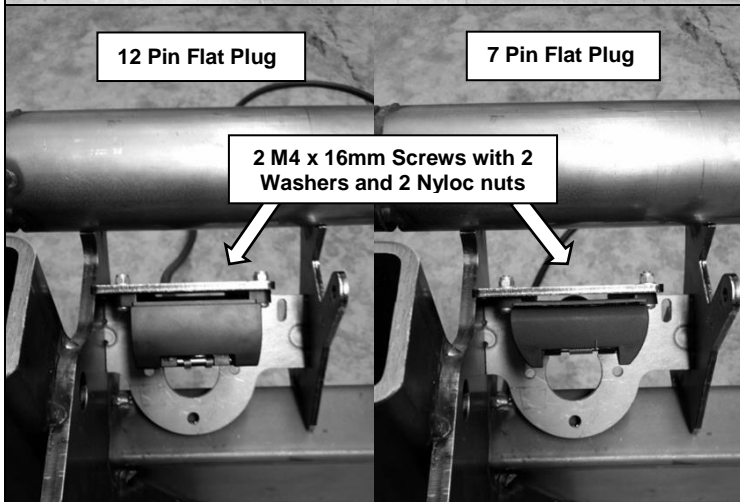

12 Pin Flat Plug

7 Pin Flat Plug

2 M4 x 16mm Screws with 2 Washers and 2 Nyloc nuts

For fitment of flat trailer plugs:

27. Using the appropriate mounting holes as shown and fasteners supplied with the trailer plug, attach the trailer plug to the trailer plug bracket on the RSTB.

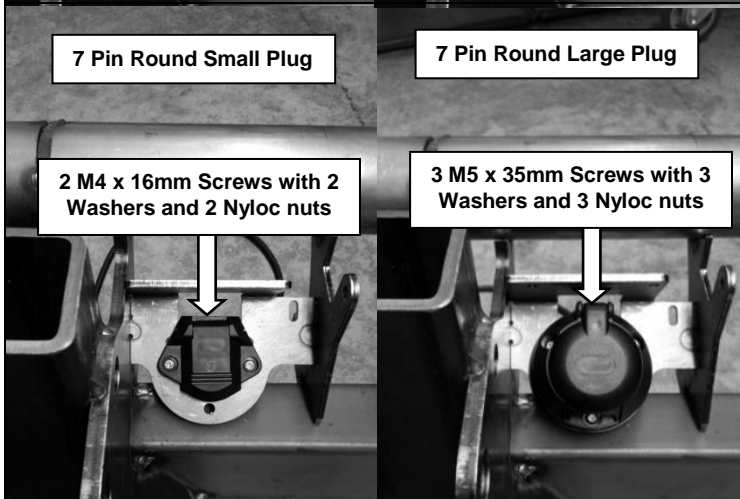

7 Pin Round Small Plug

7 Pin Round Large Plug

2 M4 x 16mm Screws with 2 Washers and 2 Nyloc nuts

3 M5 x 35mm Screws with 3 Washers and 3 Nyloc nuts

For fitment of round trailer plugs:

28. Using the appropriate mounting holes as shown and fasteners supplied with the trailer plug, attach the trailer plug to the trailer plug bracket on the RSTB.

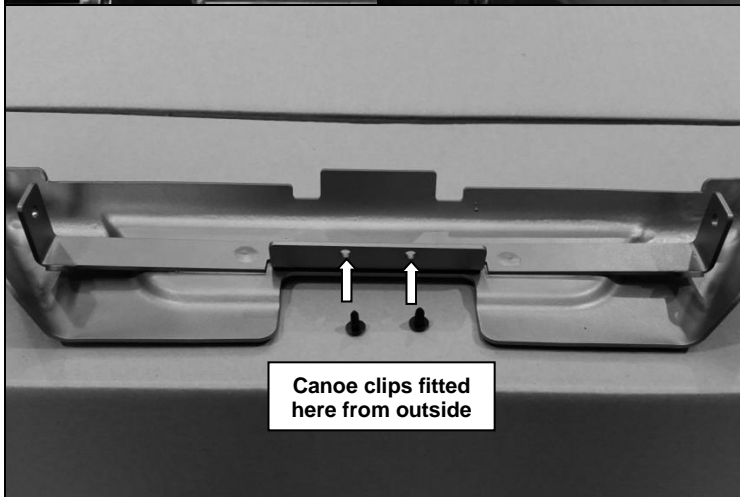

Canoe clips fitted here from outside

29. Fit 2 plastic canoe clips to the lift up panel using the holes as shown.

PREPARE REAR STEP TOW BAR (RSTB)

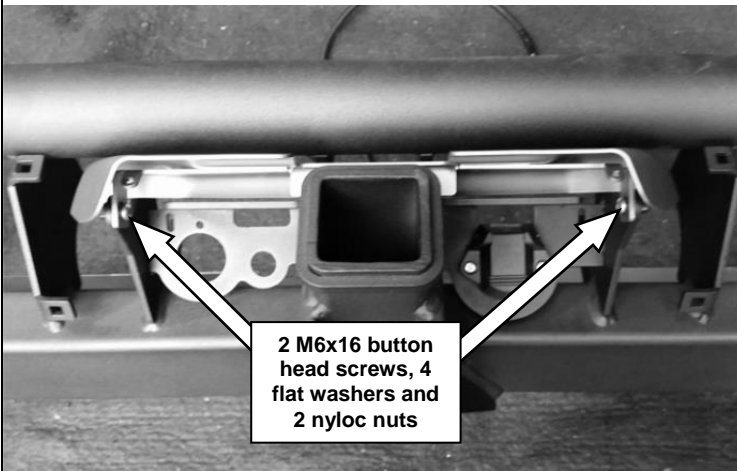

30. Attach the lift up panel to the pivot plates on the RSTB using 2 M6x1.0x16 button head screws, 4 M6 flat washers (black) and 2 M6 nyloc nuts.
31. Tighten the screws enough to ensure the lift up panel is centralised with minimal sideways movement, but still able to lift up and down freely.



32. Rotate the RSTB 180° so it is now resting flat on the ground as shown.

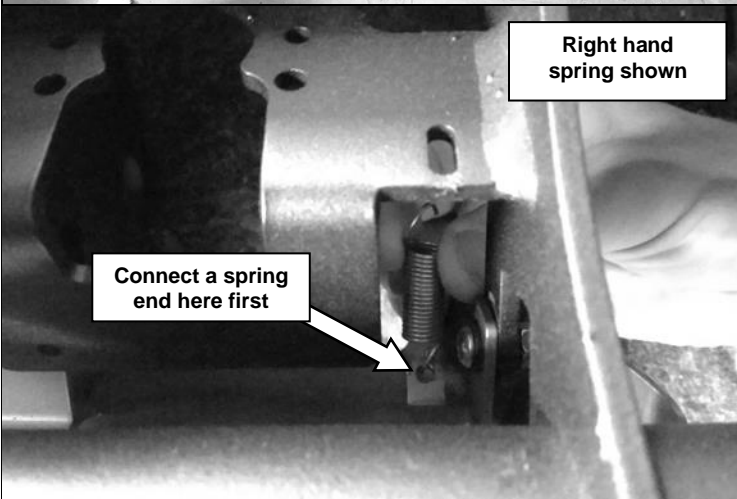

33. Connect 2 springs between the RSTB and lift up panel. From above, first connect one end of each spring to the lift up panel as shown.

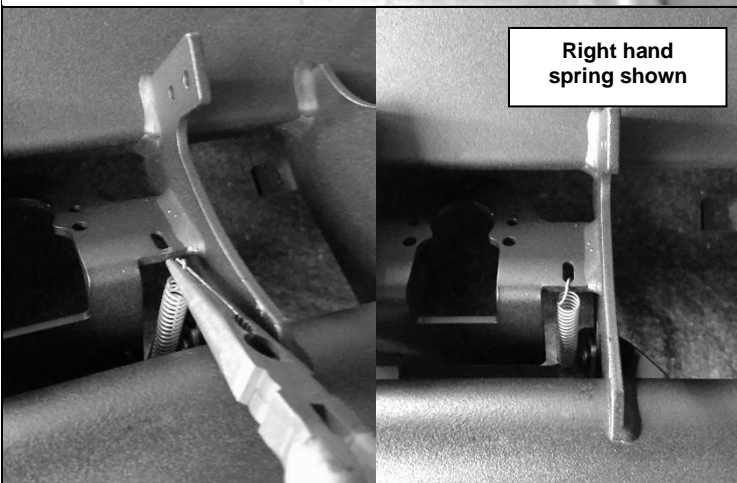
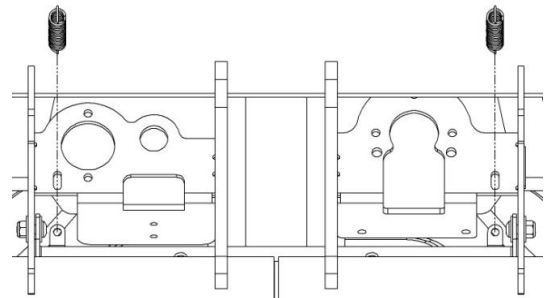

34. Using pliers, stretch the free end of each spring up to the bracket on the RSTB as shown.



Warning: Safety glasses should be worn for this operation as the spring may slip off the pliers if not clamped tightly.

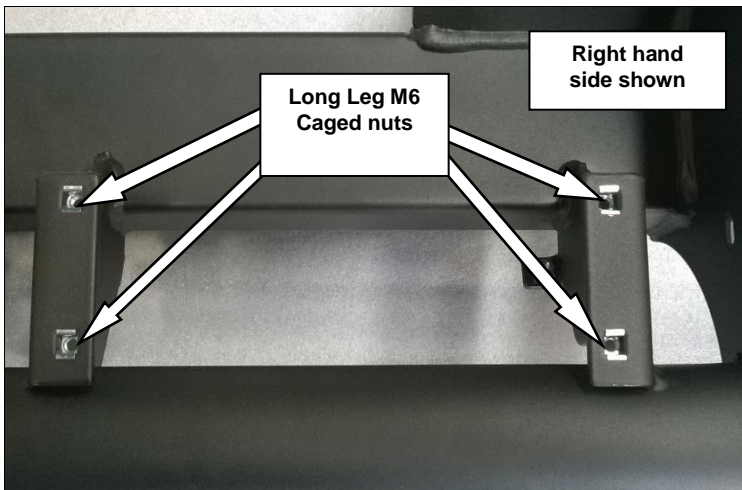

35. Fit 8 long-leg M6 caged nuts to the RSTB. Fit 4 caged nuts to the right side as shown and 4 cage nuts to the left hand side

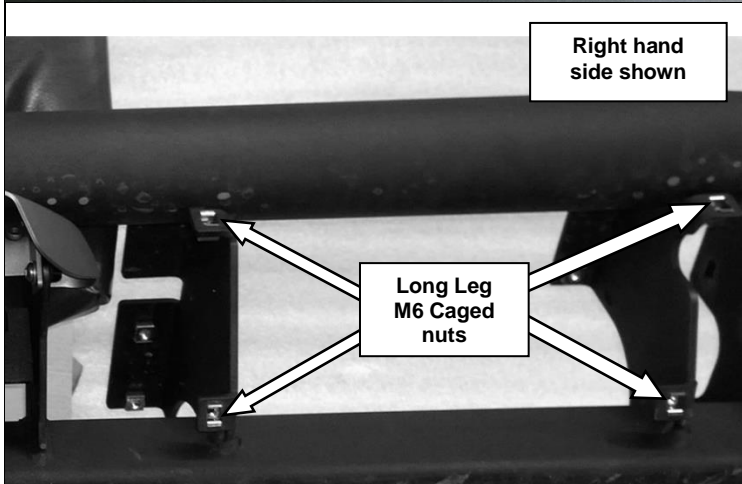

36. Rotate and support the RSTB and fit 8 long-leg M6 caged nuts. Fit 4 caged nuts to the right side as shown and 4 cage nuts to the left hand side

PREPARE BEAVER PANEL

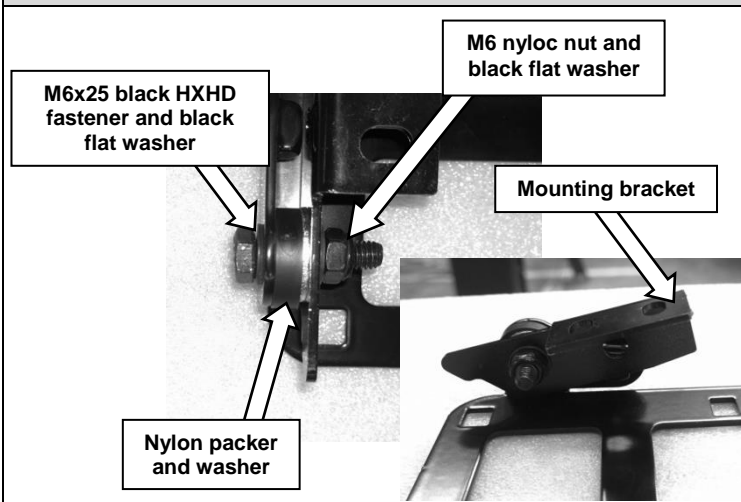

37. Assemble license plate bracket as shown taking note of mounting bracket orientation. Repeat step for opposite side of license plate bracket.
38. Tighten the screws enough so the brackets can be rotated by hand but not freely by themselves.

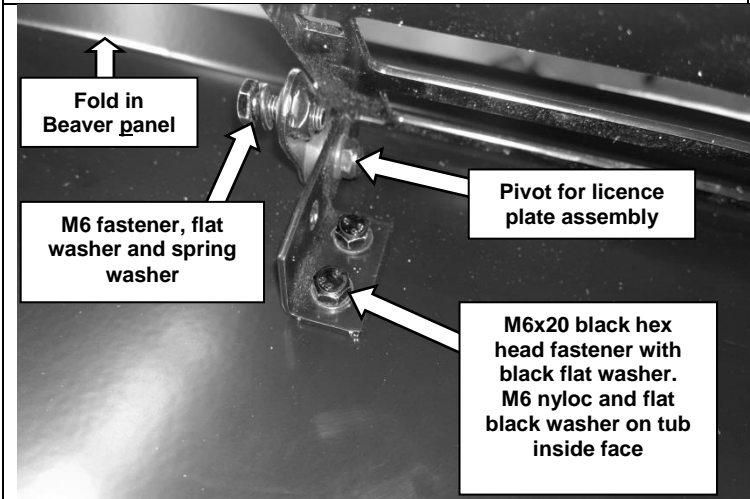

39. Fix the license plate bracket assembly to the beaver panel using 4 M6x1.0x 20 hex head screws, 8 M6 flat washers (black), and 4 M6 nyloc nuts as shown.
40. Screw in partially 2 M6 X 25 black hexhead fastener along with black M6 washer and spring washer into upper hole of licence plate frame (both sides). Note :These fasteners are used to stop licence plate frame from rotating to an open position when the vehicle is in motion.
41. Tighten all screws to the specified torque.



M6 X 1.0 - 9 Nm.



42. Fix the beaver panel assembly to the vehicle using, 2 M8x1.25x20 button head screws, 2 M6x1.0x16 button head screws, 2 M8 flat washers (SS) as shown.
Do not tighten fully at this stage



43. Continue to fix the beaver panel assembly to the vehicle using, 4 M8x1.25x20 button head screws, 4 M6x1.0x16 button head screws, 4 M8 flat washers (SS) and 4 M6 nyloc nuts.
44. Align the panel so there is even spacing around edges and align the slot in the middle with the existing slot in the rear vehicle panel.
45. Tighten all fasteners to the specified torque.



M8 X 1.25 - 22 Nm.

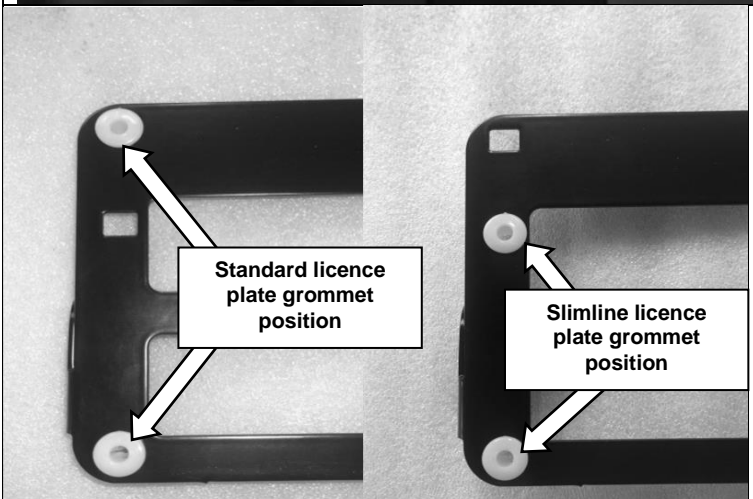

46. Insert 4 plastic grommets into number plate frame to suit licence plate size
Note: Photo shows bracket removed from vehicle for clarity



47. Using 4 screws supplied fasten licence plate to frame.

RSTB TO VEHICLE



48. With the assistance of other people or a lifting device, lift the RSTB up beneath the chassis rails aligning the threaded holes in the side of the chassis with those in the vertical surfaces of the RSTB.

Note: Take care to ensure the trailer plug wiring is not damaged during this step.

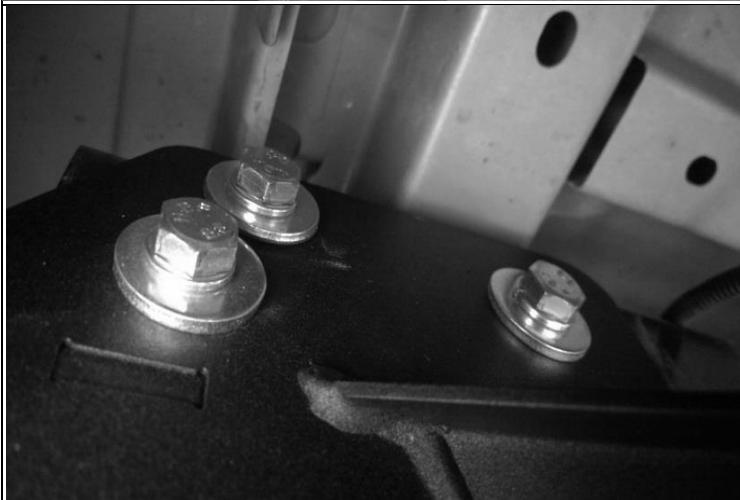

49. Fix the vertical plates of the RSTB to the threaded holes in each chassis rail using 3 M12x1.25x40 (fine pitch) hex head bolts, 3 M12 spring washers and 3 M12 flat washers per chassis rail. Leave finger tight at this stage.



50. Insert the folded chassis plates in chassis and fasten the remaining horizontal mount points using 2 M12x1.25x40 (fine pitch) hex head bolts, 2 M12 spring washers and 2 M12 flat washers. Leave finger tight at this stage.
51. Check RSTB spacing to vehicle and tighten all fasteners to the specified torque.
52. Connect 6-pin connector end of trailer plug harness to RSTB harness.



M12 X 1.25 - 95 Nm.

STEP PLATE TO RSTB

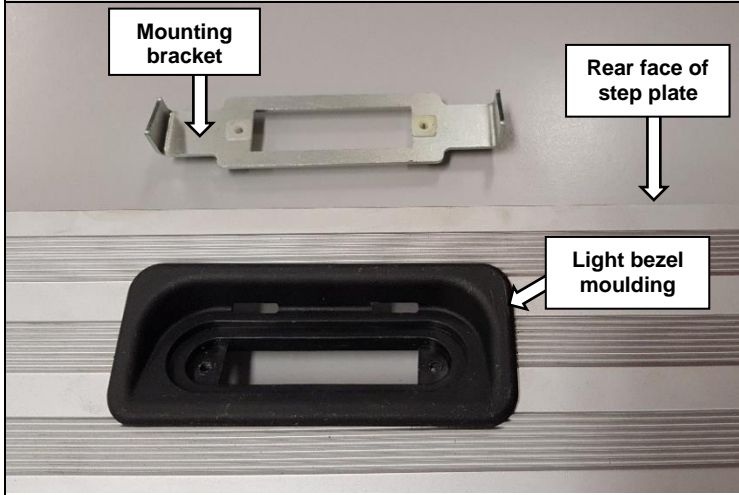

53. Push 2 plastic snap-in small grommets through the 2 holes in the LED mounting bracket as shown. Install the grommets from the underside of the bracket.
54. Fit the light bezel moulding to the step plate extrusion as shown with the deep section facing towards the rear face of step plate.



55. **Remove the foam ring from the LED lamp and discard.**
56. Place the LED lamp in the light bezel moulding and fix to the mounting bracket using the screws supplied in the lamp kit.

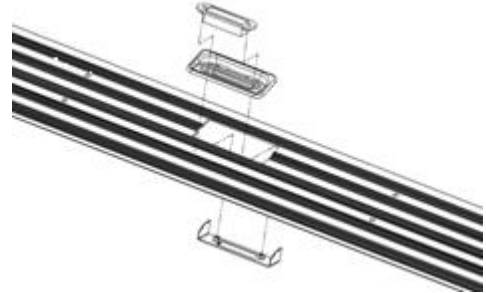

57. Fit the clear plastic plugs supplied in the lamp kit to the LED lamp above the screws.

STEP PLATE TO RSTB

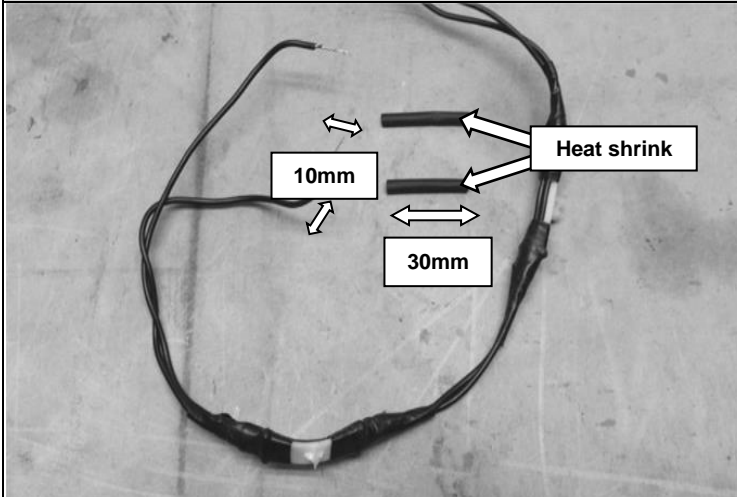

58. Cut licence plate loom at branch point and remove 10mm of the plastic insulation coating from the license plate lamp loom.
59. Insert a 30mm piece of heat shrink over each wire as shown.

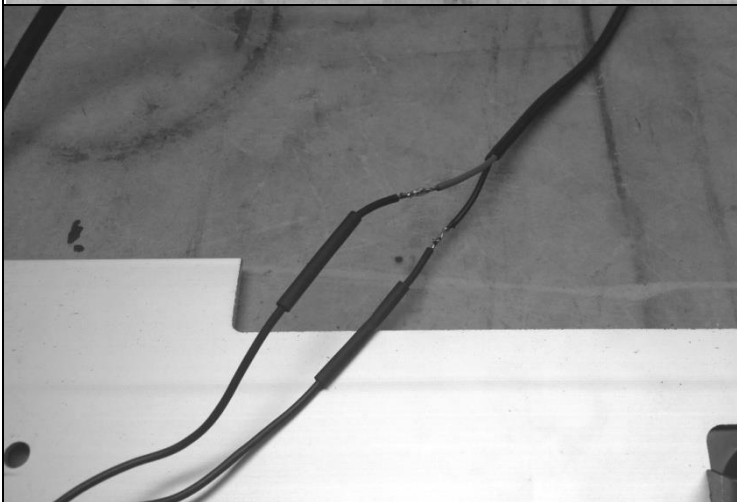

60. Using a soldering iron and solder, join the LED lamp wires to the license plate lamp or sensor loom use a multimeter to verify positive and negative wire

Note: The LED lamp is polarity sensitive so it is important to identify and solder the correct wires together.

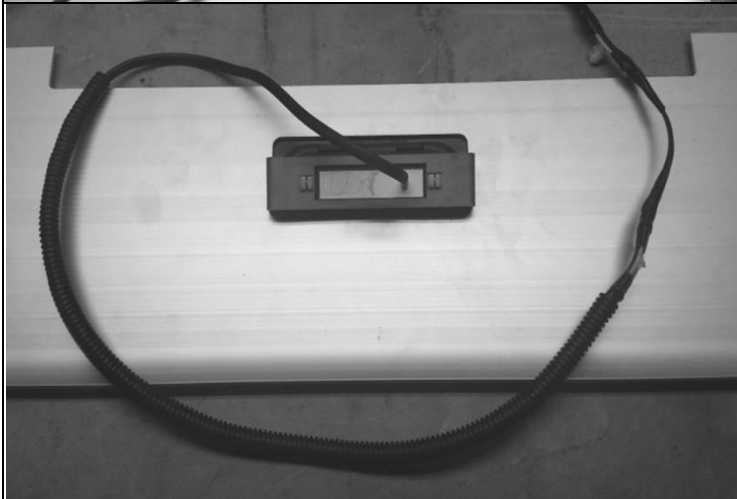

61. Place the heat shrink over the soldered wires and use a heat gun to shrink in place.
62. Further protect each join with corrugated tubing and insulation tape.



63. Attach the step plate extrusion to the RSTB using 8 M6x1.0x16 button head screws taking care not to damage the LED lamp wire.
NOTE : Do not install washers under the 8 M6 button head screws that are fixing the step plate extrusion to the RSTB
64. Route the LED lamp loom through the RSTB to its fastening point identified in step 3 and connect to the existing connector. Ensure the licence plate LED lamp functions correctly

PREPARE RSTB/VEHICLE FOR PANELS

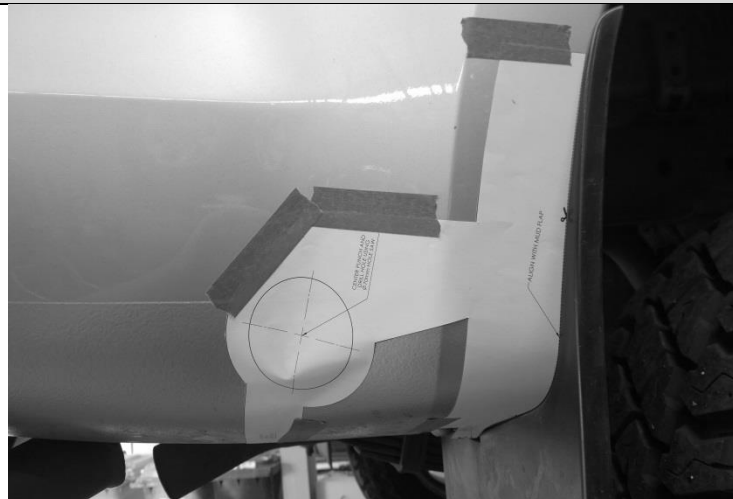

65. Place the cutting template on the right hand rear side panel of the tub aligning it with the mud flap and bottom edge of the tub. Use masking tape to hold in place.

66. Mark the centre of the cutting hole on the rear side panel and then remove the template.

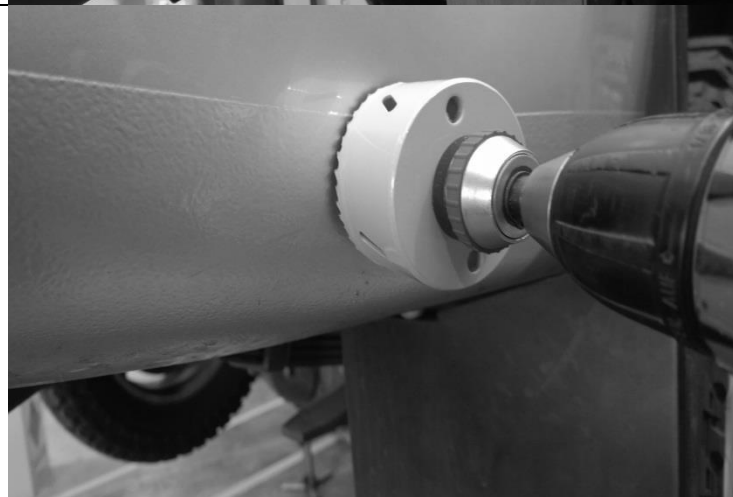

67. Using a Ø70mm hole saw, drill through the rear side panel using the mark from the previous step as the centre point of the hole.



68. Repeat steps 59-61 for the left hand rear side panel using the opposite side of the template.

69. De-bur each hole to remove sharp edges.

70. Treat raw edges with a rust preventative paint.

Right DMAX wing shown

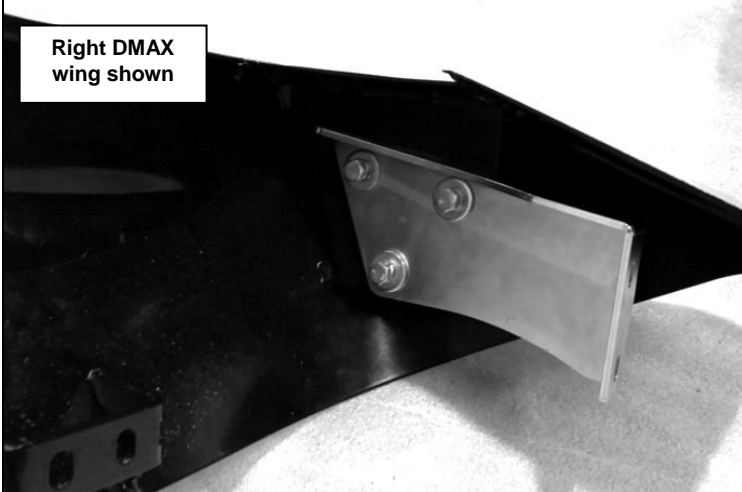

71. Fix a wing mount bracket to each DMAX wing using 3 M8x1.25x25 hex head bolts, 3 M8 spring washers, 3 M8 flat washers and a wing triple nut plate. Orientate each bracket as shown. Leave bolts finger tight at this stage.

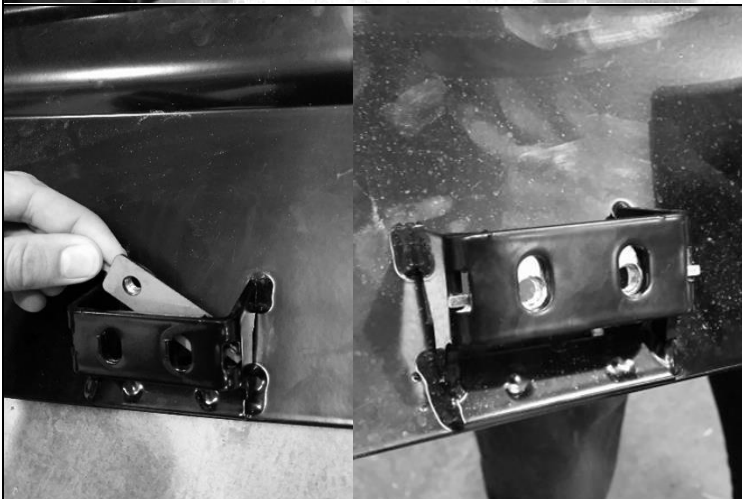
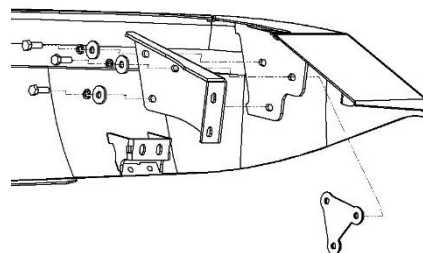

72. Place a wing double nut plate inside the middle bracket of each DMAX wing as shown.

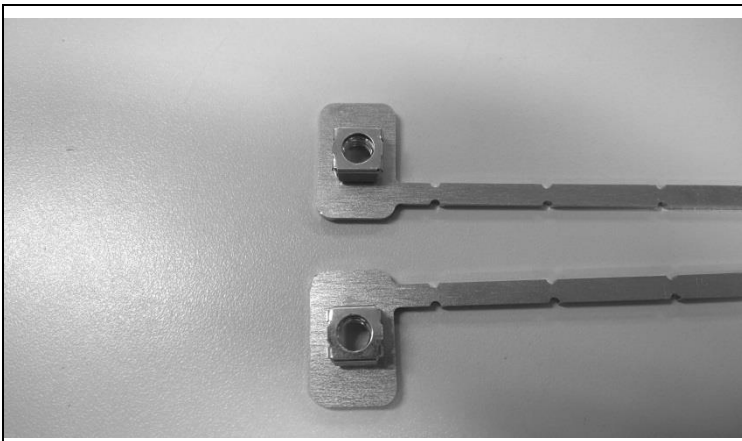

73. Insert 1 M10 caged nut into each cage nut plate as shown.

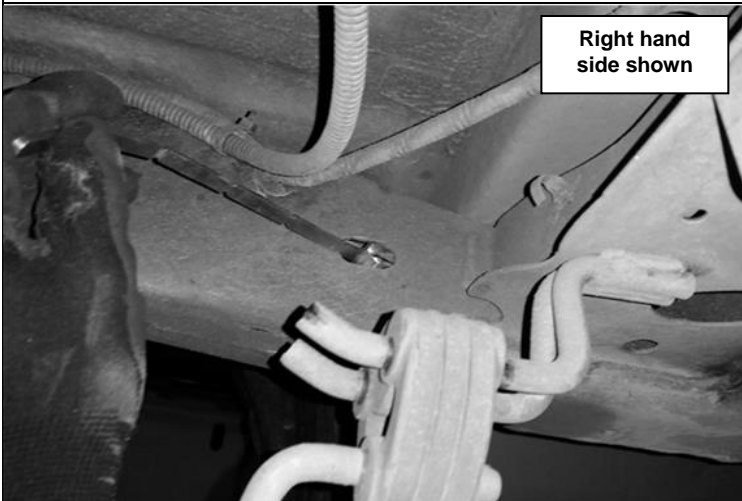

74. Insert cage nut plate rearwards through a hole on the inner chassis rail face into the chassis rail as shown.

75. Position the caged nut in line with the hole on the outer chassis rail face approximately 150mm rearwards of the inner hole and hold in place.

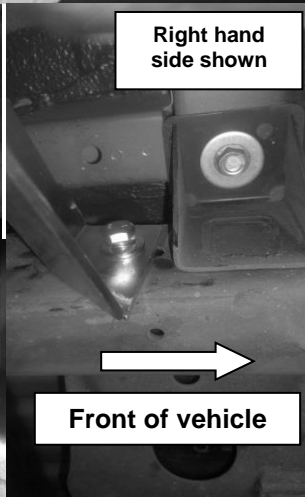

76. Position a wing mount strut under the tub and fix to the cage nut plate in the chassis rail using 1 M10x1.5x35 hex head bolt, 1 M10 spring washer and 1 M10 flat washer. Leave finger tight at this stage.

Note: Strut should be positioned with notched face leading towards wheel arch as shown.

77. Repeat steps 74-76 for the opposite side.

PANELS TO RSTB/VEHICLE



78. Pass the front bracket of each DMAX wing through the $\text{\O}70\text{mm}$ hole in the tub and fasten to the wing mount strut using 2 M8x1.25x25 hex head bolts, 4 M8 flat washers and 2 M8 nyloc nuts. Leave bolts finger tight at this stage.

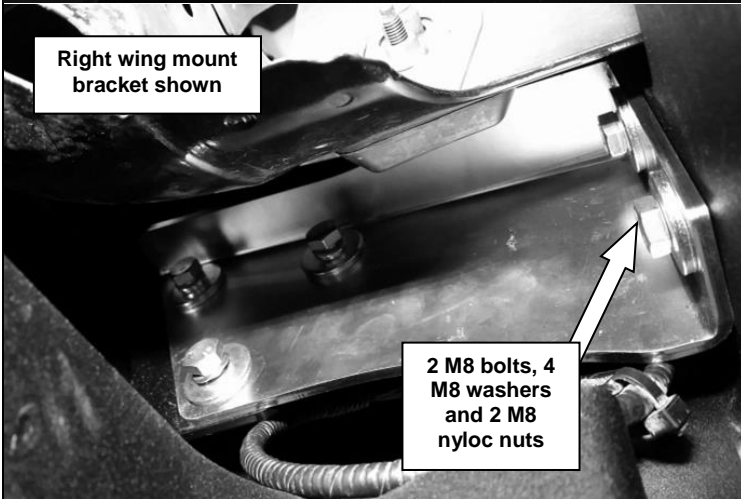
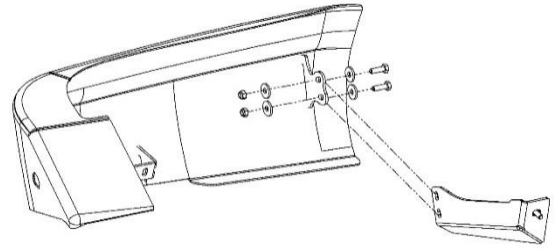

79. Fix the wing mount bracket of each DMAX wing to the RSTB using 2 M8x1.25x25 hex head bolts, 4 M8 flat washers and 2 M8 nyloc nuts. Do not fully tighten at this stage.



80. Fix the middle mount bracket of each DMAX wing to the RSTB using 2 M8x1.25x25 torx head bolts, 2 M8 spring washers and retainer plate as shown. Do not fully tighten at this stage.

Note: Position the retainer plate under the head of the torx head bolts and spring washers in place of a conventional washer



81. Position each DMAX wing so there is an even 6-8mm gap to the side vehicle panels.



82. Position each DMAX wing so they there is an even gap to the mud flap as shown.

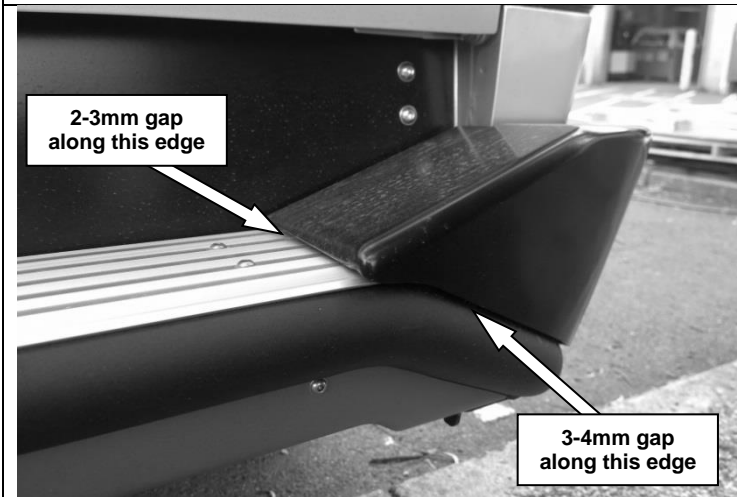

83. Position each DMAX wing so they sit evenly on the step plate extrusion and there is an even gap to the tube as shown.



84. Tighten all the M8 bolts that retain each DMAX wing to the specified torque. Tighten the M10 bolts that secure the wing mount strut to chassis to the specified torque.



M8 X 1.25 - 22 Nm.



M10 X 1.5 - 44 Nm.

Note: Check that all clearances are maintained as the fasteners are tightened.

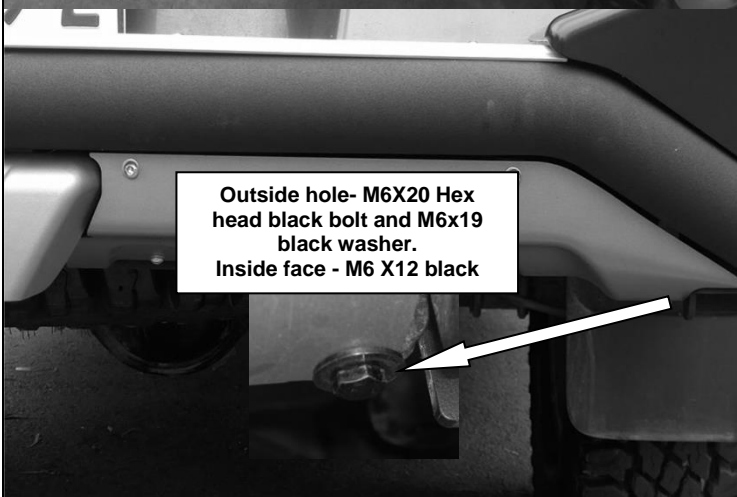

85. Attach the diffuser panels to the RSTB using 8 M6x16 button head screws and M6 stainless flat washers.
86. For the outer most holes on each panel, use M6X20 Hex head black bolt and M6x19 black washer, M6 X12 black washer and M6 nyloc nut as shown

PANELS TO RSTB/VEHICLE

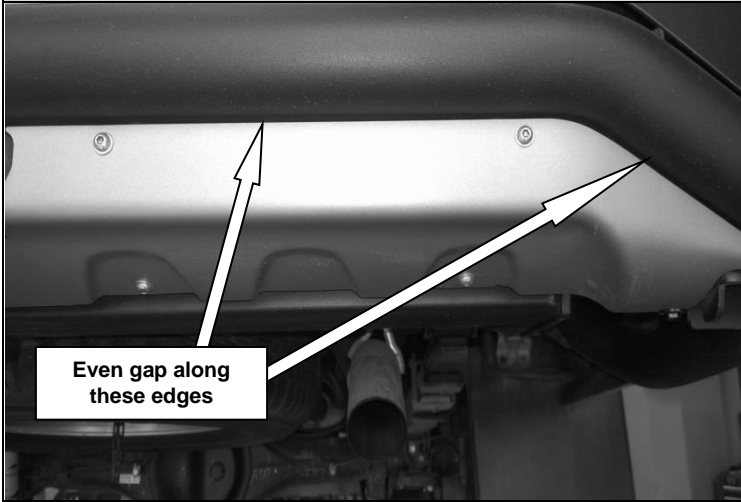

87. Position each diffuser panel so there is an even gap between the panel and the RSTB tube. Tighten fasteners to the specified torque.

 M6 X 1 -9 Nm.



88. Reattach the spare wheel beneath the vehicle tub as shown.



89. Using the 10mm spanner provided tighten the licence plate retaining bolt on both sides to secure the licence plate in an upright position



90. Store tow tongue, pull pin and R-clip in a safe and secure location when not in use.

FITTED PRODUCT



FITTED PRODUCT



TRAILER CAMERA PLUG, ANDERSON PLUG AND AIR-LINE FITTING



TRAILER PLUG

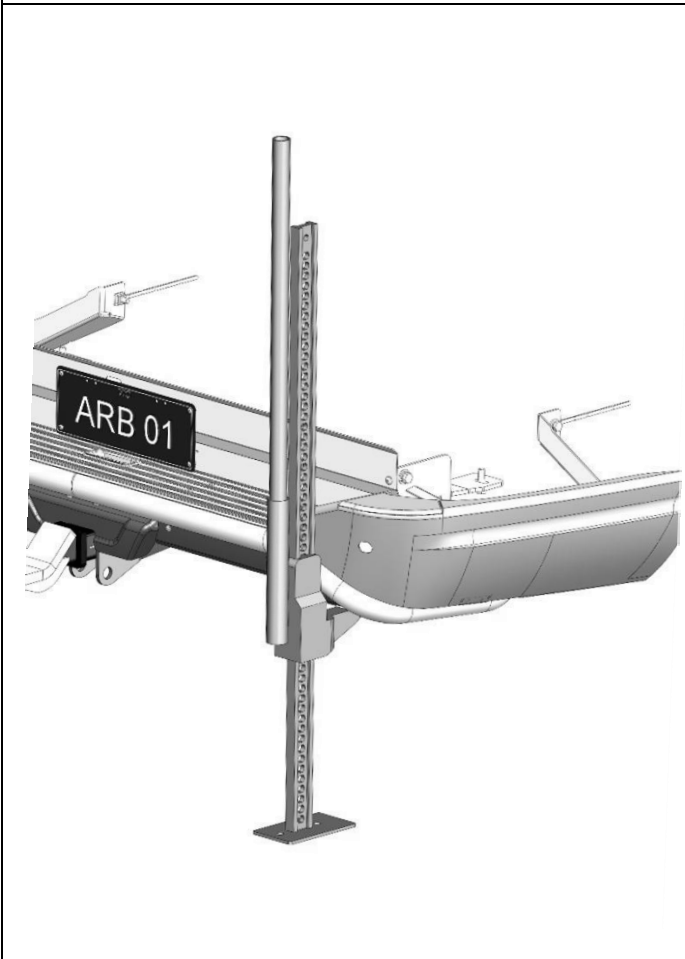

HIGH LIFT JACK LOCATION - CORNER OF RSTB

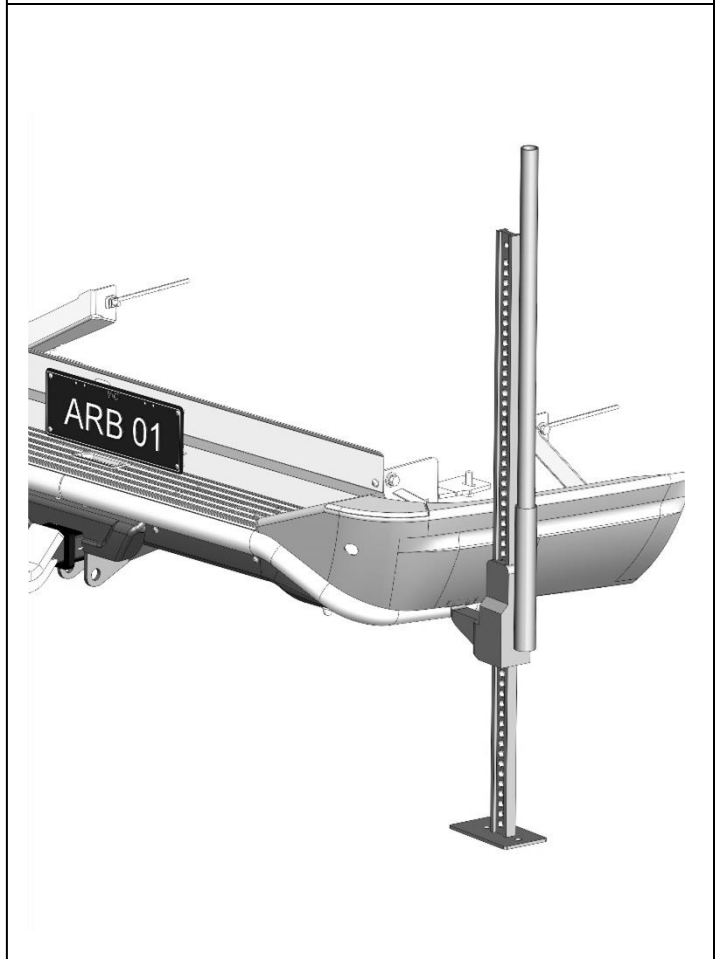

HIGH LIFT JACK LOCATION - SIDE OF WING/ABOVE TUBE

